



سالم محيي الدين  
**SALEM MOHIYADDIN**  
SALEM MOHIYADDIN BIN SAIF&BROS.GROUP



# COMPANY HISTORY





Salem Mohiyaddin Bin Saif & Bros. Group of companies ( SMBC ) is one of the oldest established and long-standing business groups in the Sultanate of Oman. Having operations centralized in the Southern Region of Dhofar it created demand all over Oman. The four brothers, Mr. Aqeel Bin Mohiyaddin Bin Saif , Mr. Abdullah Bin Mohiyaddin Bin Saif, Mr. Hafidh Bin Mohiyaddin Bin Saif and Mr. Salem Bin Mohiyaddin Bin Saif established the flagship and parent Company named as Salem M niya din Bin Saif & Bros. Trading & Contracting Company in the year 1975 in Salalah.

They started the Company as a Registered Partnership firm on 26th June 1975, for manufacturing and trading in building materials in the Dhofar region. Since then, the family based organization, has grown into a large group of twenty plus Companies which includes manufacturing Crusher materials, Ready Mix Concrete, Concrete Blocks, Flooring and Interlock Tiles, Aluminium Fabrications, Construction, and they even have a major role in Tourism & Real Estate services. The Group is also having trading operations in various Building materials, Equipment and Spare parts etc. Thus the Company, which was started in Salalah as a local family business has grown into a big business group, serving the entire southern region (Dhofar Region) of Sultanate of Oman. The group's total employee strength is about 2500 persons and the group turnover more than RO.40 million (USD 104 million). The Group is constantly looking for business opportunities for expansion and diversification.

The following second generation family members of the 4 founder brothers Mr. Hafidh Aqeel Mr. Hussain Abdullah, Mr. Salem Aqeel, Mr. Salah Salem, Mr. Alawi Hafidh, Mr. Abdullah Aqeel, Mr. Aqeel Hafidh, Mr. Ahmed Hafidh, Mr. Mohammed Hafidh, Mr. Alawi Aqeel and Mr. Mohamed Aqeel, are managing individual business units/divisions of the Group. The Salem Mohiyaddin Group has grown and established itself as a long standing business entity with its strong business ethics, commitment to quality of its products and honest customer service. Highly experienced personnel blend the latest development of concrete technology in production and quality control. The Headquarters of the Group of Companies is situated in Salalah.

Diversification has been no stranger to the growth of SMBC. Today there are eight permanent facilities for the production of ready mix concrete, interlock paver tiles, concrete masonry block and concrete curbstones, while there are 6 temporary production facilities erected at site exclusively for projects. Two more temporary facilities are proposed and will be fully functioning by the start of 2016.

SMBC has been a landmark in Oman, as we are committed to understanding the needs of our customers, providing solutions and then delivering not only superior products but also superior customer service. With these cornerstones in place our vision remains clear " We aspire to be recognized as the best corporate house in the Middle East for large, complex and demanding construction projects. We are working to become a market leader in the manufacturing of ready-mix concrete, concrete masonry blocks, concrete curbstone, interlock tiles and other pre- cast concrete products. We are committed to deliver products of great value and quality on time and safely. A company that our clients want to align with, our customers can rely upon and our employees are proud to work for. A company with an open mind, ready to embrace new opportunities and a drive to deliver with exceptional value. "



# MESSAGE FROM BOARD OF DIRECTORS





Dear friends, colleagues and valued customer,

From humble beginnings in 1975, the SMBC Group of Companies has been on an epic journey towards business excellence while delivering the very best to its customers. The logo of Salem Mohiyaddin Bin Saif & Bros. Trading and Contracting Co. LLC. depicts its mission "Innovative Efficiency".

Innovation means doing something different, differently. Efficiency in technical terms is the ratio of the useful work performed by a man or machine compared with the inputs needed to achieve it and trying to be more and more efficient. So the product of innovation and efficiency is the best, in each and every task at hand and that's what makes SMBC stand apart from the crowd.

As a forward looking professional company, we believe on planning for the long term & have a well laid out HR policy for our employees. Our people are the key to our success and we take measured steps to build skill and efficiency in our staff to help them achieve their professional goals. We always ensure full participation of our employees and suppliers in achieving our objectives. Open management policies, transparent business arrangements are the areas that do carry special significance.

We are always trying our best to deliver in the least possible time. We always prefer to give best quality as per our customer's desire. We strictly concentrate on quality from the starting of purchase and manufacture of raw materials up to its final completion.

Not just a leap of faith but achieving it, brick by brick and pound by pound with powering execution, commitment & professionalism. The future beckons with the promise of bigger challenges. The present is giving us the strength to thrust ahead.

Hafidh Aqeel Mohiyaddin Bin Saif  
General Manager  
(On behalf of Board of Directors)



# PAVERS

Uni

المتعرج

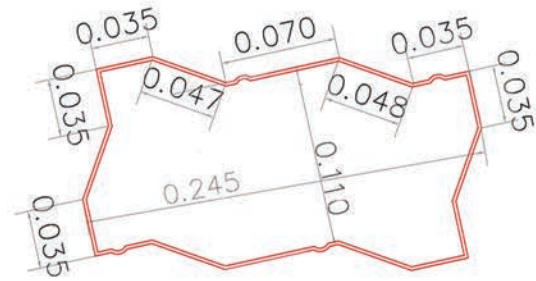

Length(mm)	210mm
Width(mm)	110mm
Thickness(mm)	60mm
No.Of Pieces Required For 1mArea	38.46pcs

Length(mm)	210mm
Width(mm)	110mm
Thickness(mm)	80mm
No.Of Pieces Required For 1mArea	38.46pcs

Model-1

Model-2

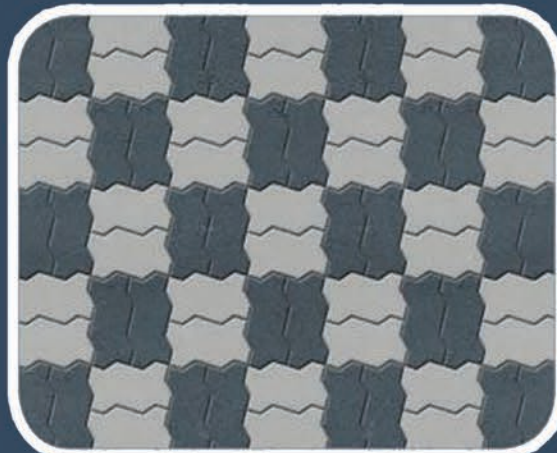
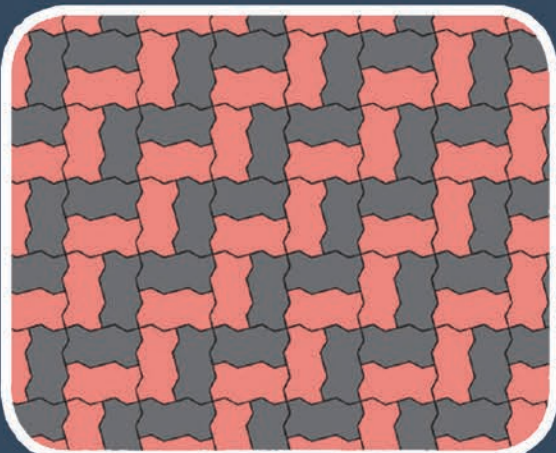



# PAVERS

## OCTAGONAL الثماني الاضلاع

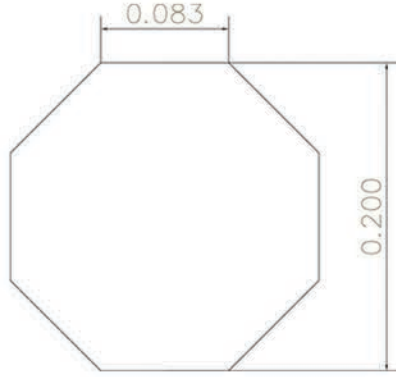
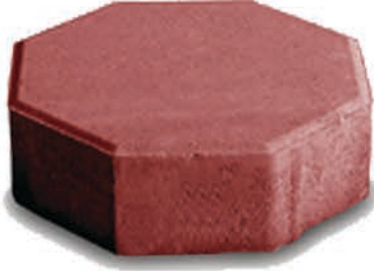

Length(mm)	200mm
Width(mm)	200mm
Thickness(mm)	60mm
No.Of Pieces Required For 1mArea	31.25pcs

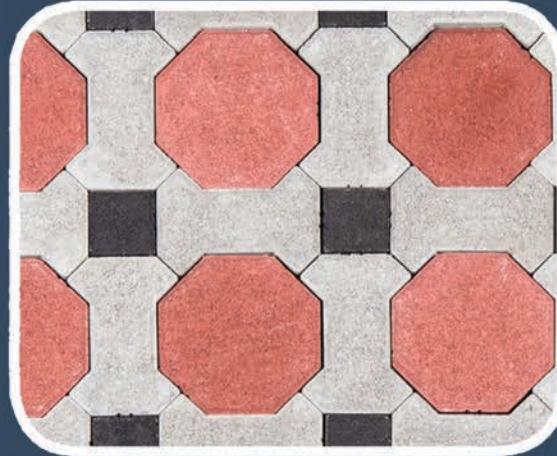
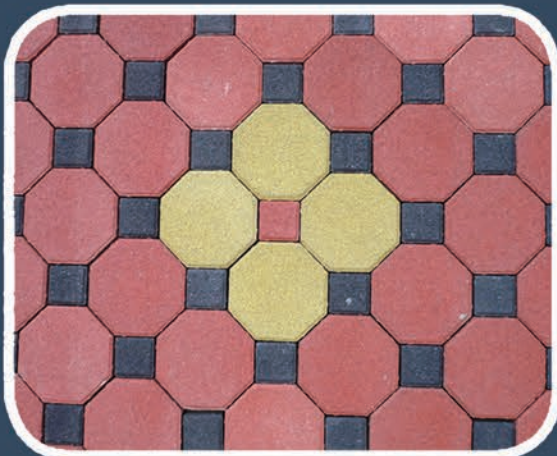



# PAVERS

## QUADRO العظمة

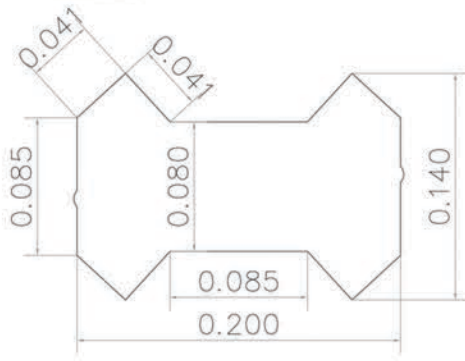

Length(mm)	200mm
Width(mm)	200mm
Thickness(mm)	60mm
No.Of Pieces Required For 1mArea	52.63pcs

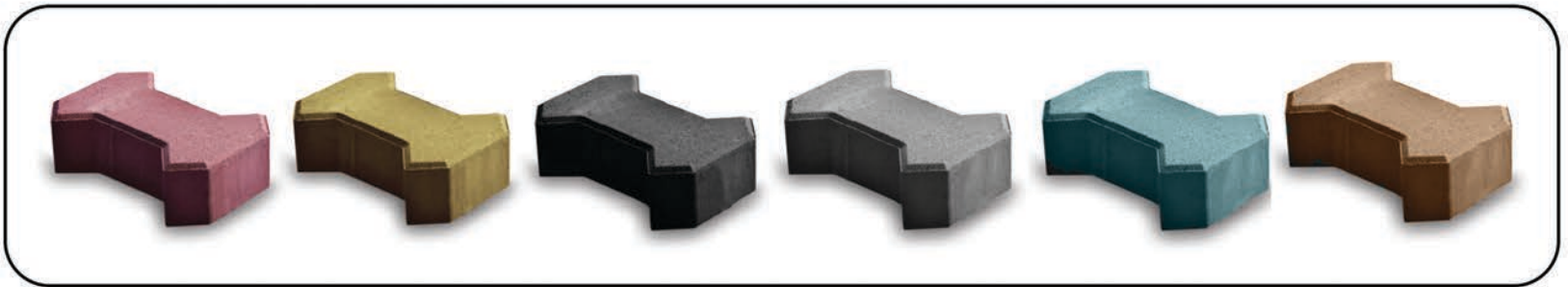



# PAVERS

## RECTANGULAR المستطيل



Length(mm)	200mm
Width(mm)	100mm
Thickness(mm)	60mm
No.Of Pieces Required For 1mArea	50pcs

Length(mm)	200mm
Width(mm)	100mm
Thickness(mm)	80mm
No.Of Pieces Required For 1mArea	50pcs

### Model-1

### Model-2

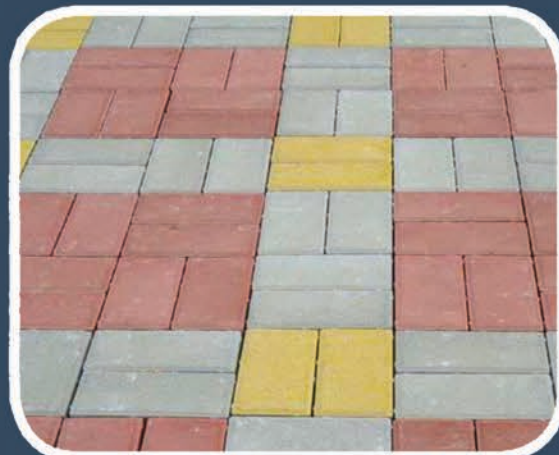
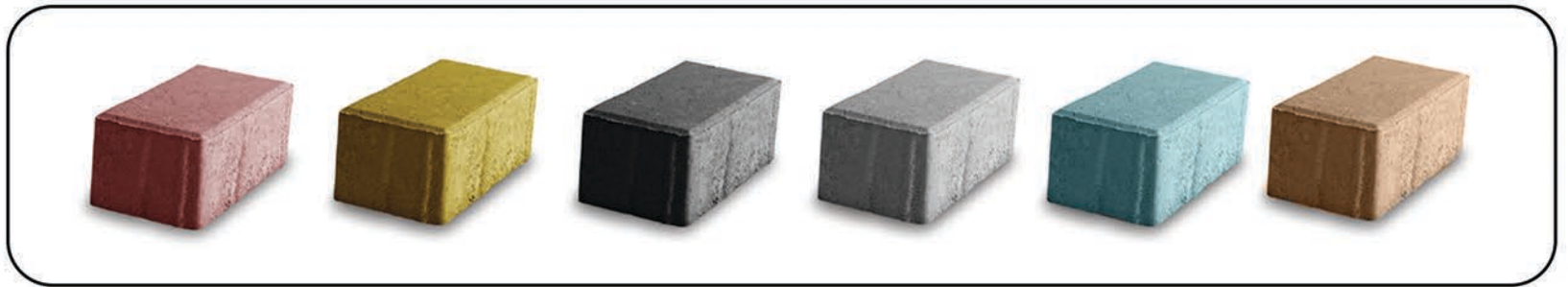



# PAVERS

## SQUARE المربع

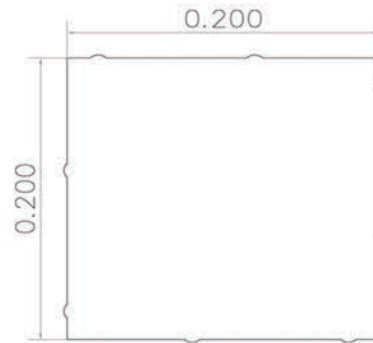

Length(mm)	200mm
Width(mm)	200mm
Thickness(mm)	60mm
No.Of Pieces Required For 1mArea	25pcs

Length(mm)	200mm
Width(mm)	200mm
Thickness(mm)	80mm
No.Of Pieces Required For 1mArea	25pcs

### Model-1

### Model-2

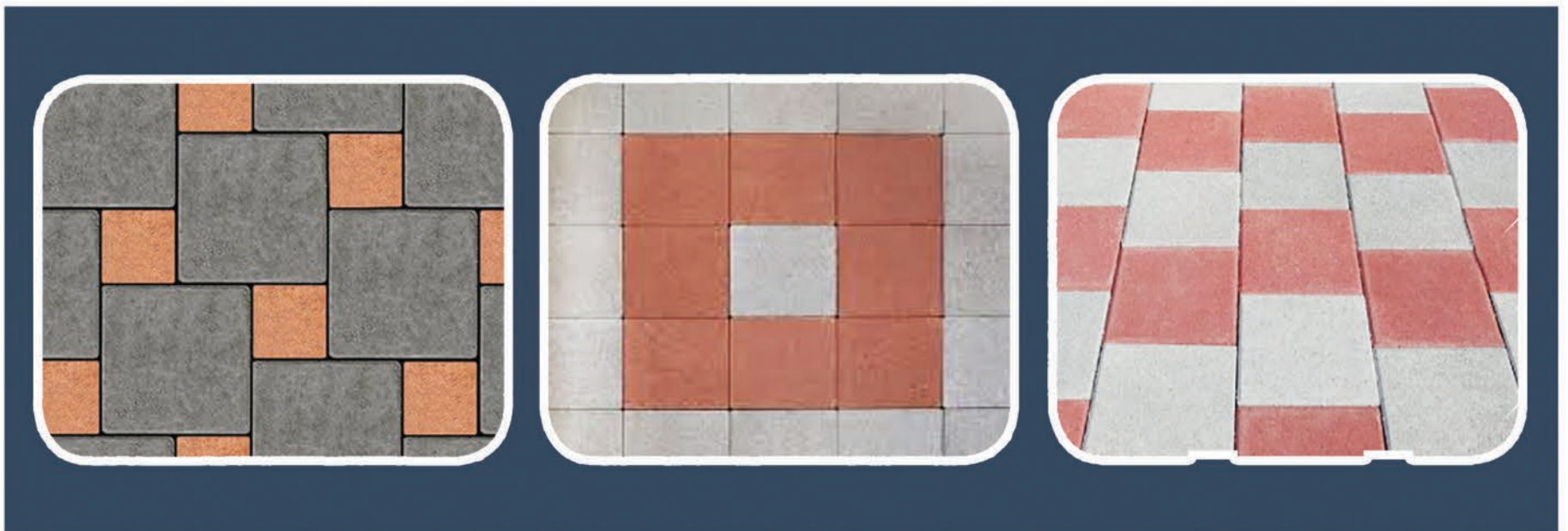
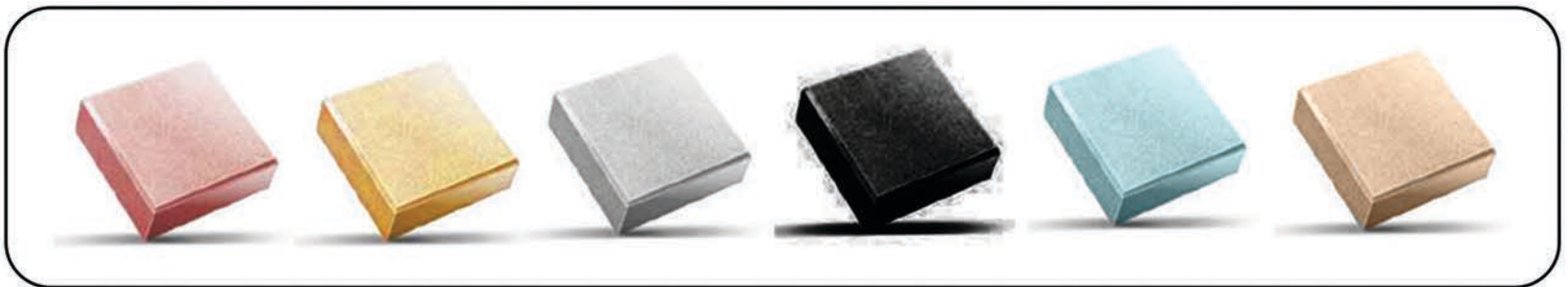



# PAVERS

## SQUARE المربع

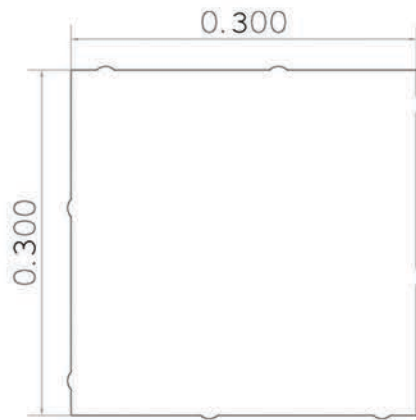

Length(mm)	300mm
Width(mm)	300mm
Thickness(mm)	60mm
No.Of Pieces Required For 1mArea	11.11pcs





# PAVERS

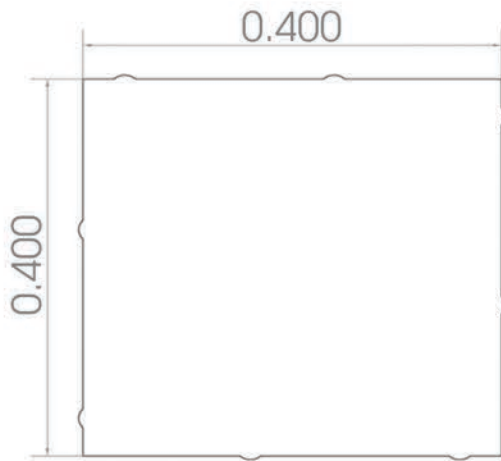

## SQUARE المربع

Length(mm)	400mm
Width(mm)	400mm
Thickness(mm)	60mm
No.Of Pieces Required For 1mArea	6.25pcs





# PAVERS

## SQUARE المربع

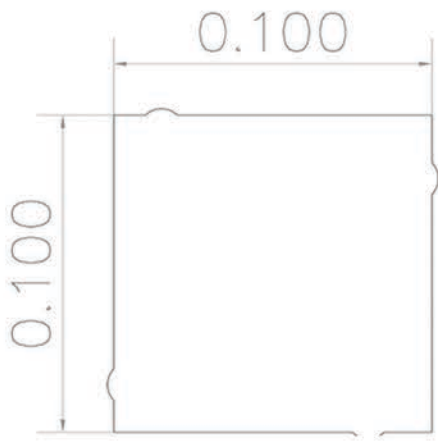

Length(mm)	100mm
Width(mm)	100mm
Thickness(mm)	80mm
No.Of Pieces Required For 1mArea	100pcs

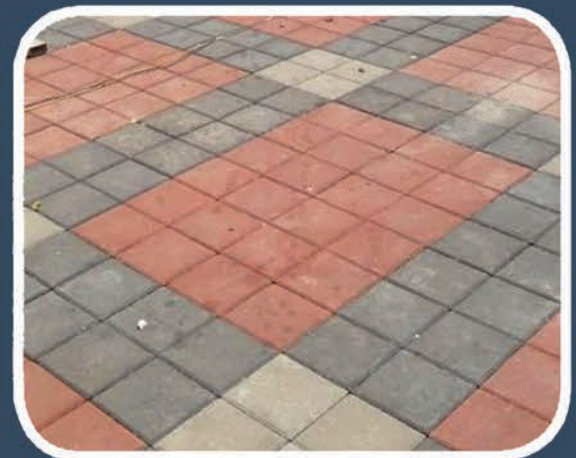



# PAVERS

## SQUARE العرربع

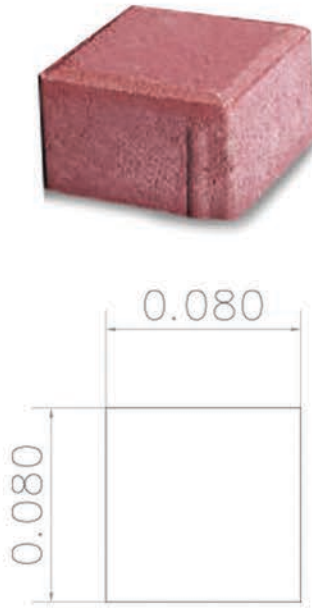

Length(mm)	80mm
Width(mm)	80mm
Thickness(mm)	60mm
No.Of Pieces Required For 1mArea	144.4pcs

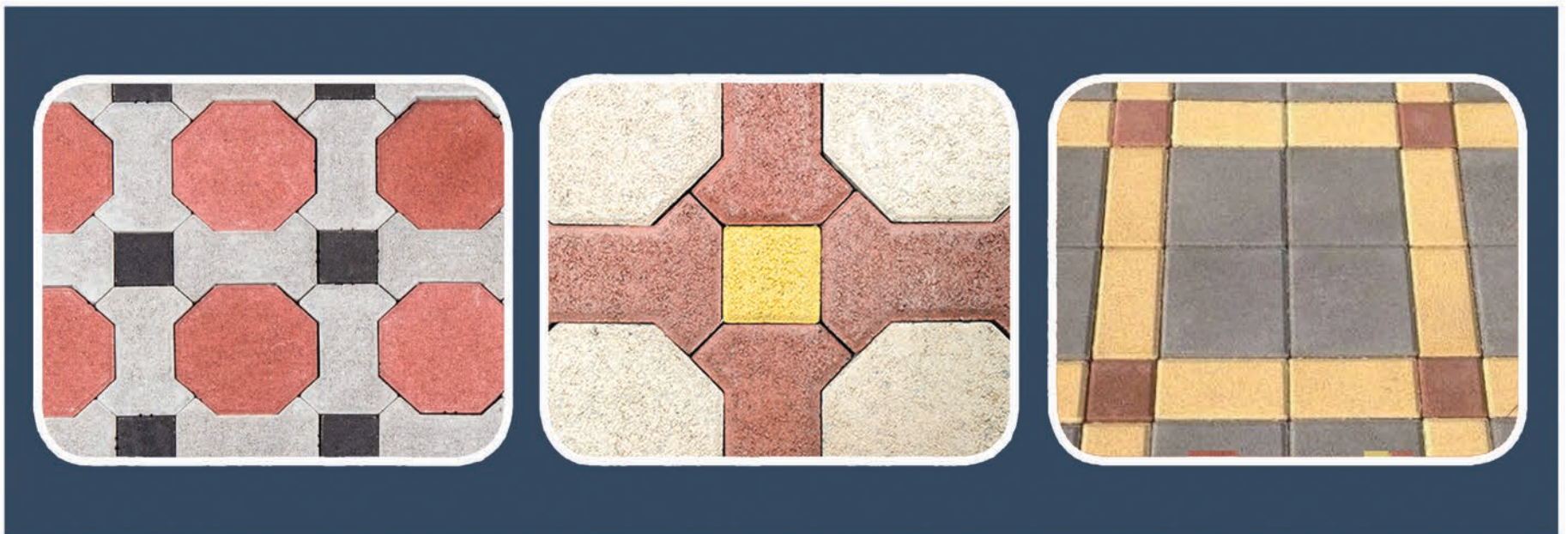
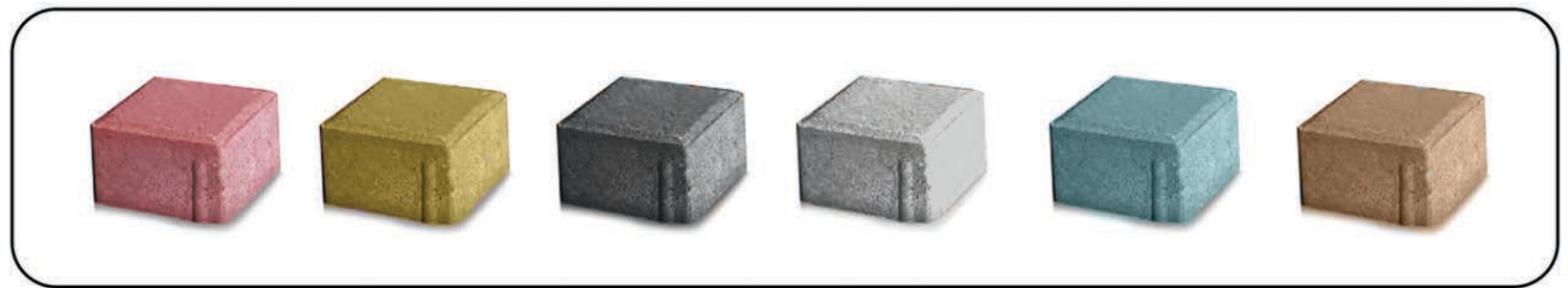



# PAVERS

## RUMBUS رومبوس

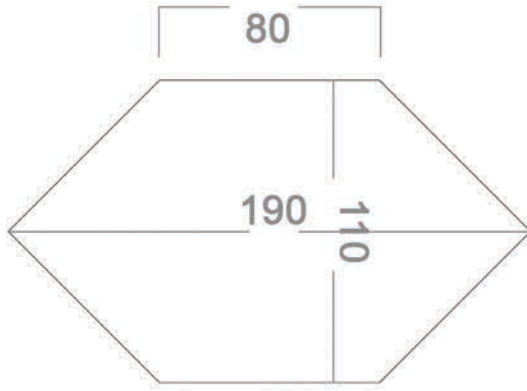

Length(mm)	190mm
Width(mm)	110mm
Thickness(mm)	60mm
No.Of Pieces Required For 1mArea	65.7pcs





# PAVERS

## POLYGON 1 المضلّع 1

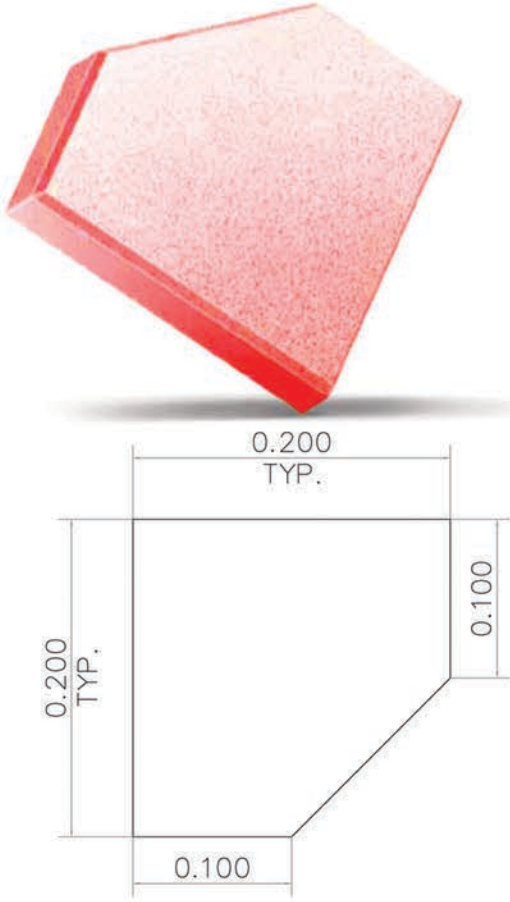

Length(mm)	200mm
Width(mm)	200mm
Thickness(mm)	60mm
No.Of Pieces Required For 1mArea	20.7pcs

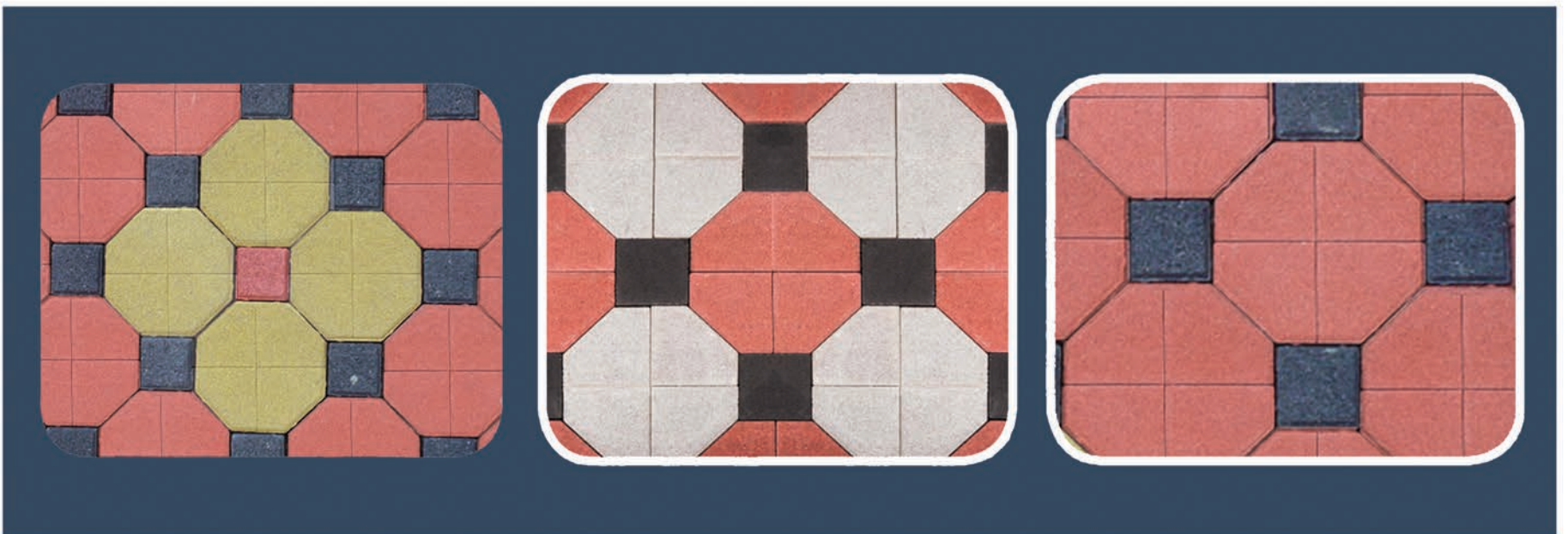
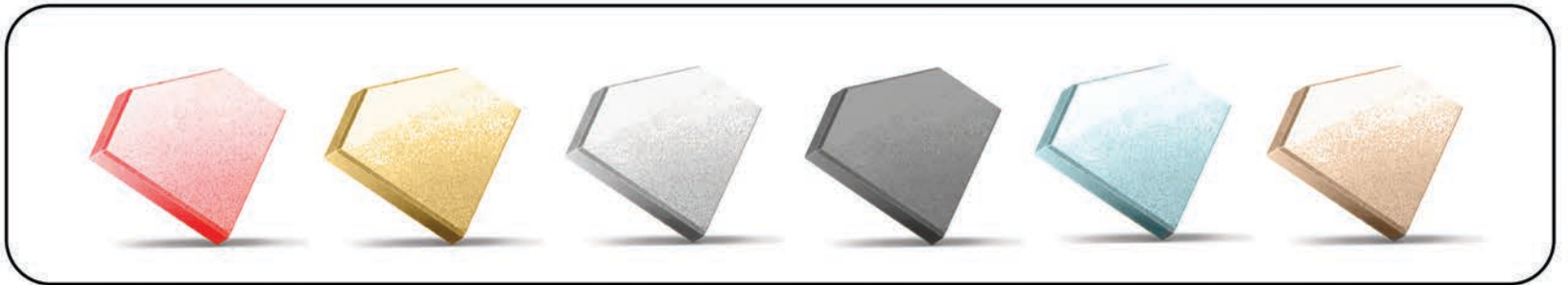



# PAVERS

## POLYGON 2 المضلّع 2



Length(mm)	250mm
Width(mm)	200mm
Thickness(mm)	60mm
No.Of Pieces Required For 1mArea	20.4pcs

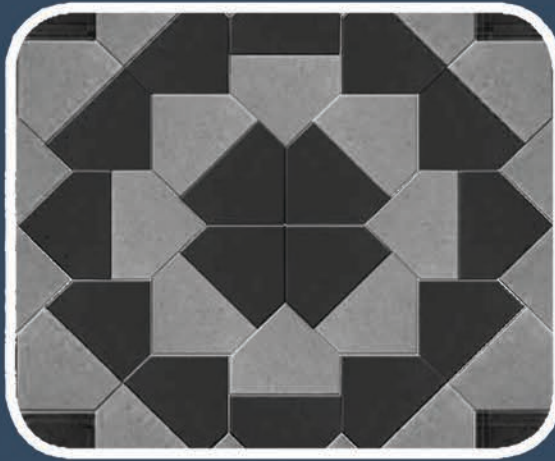
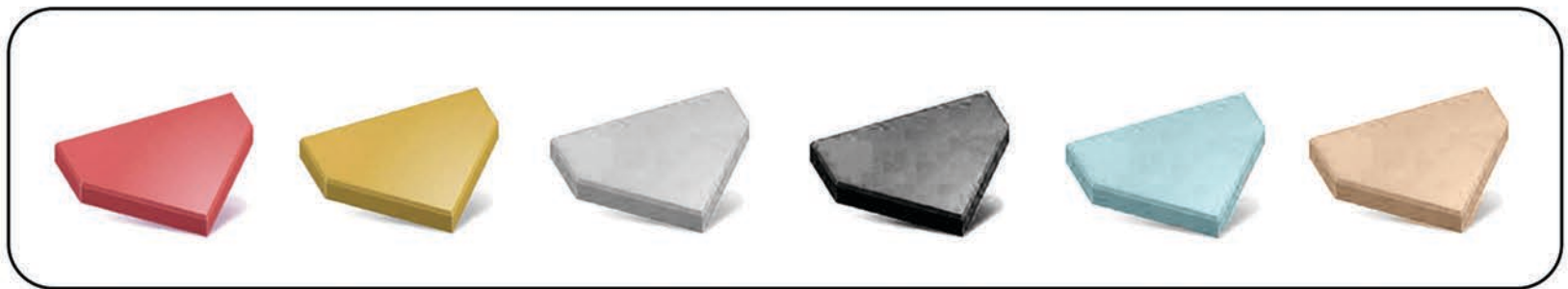



# PAVERS

## PYRAMID

## الهرمي

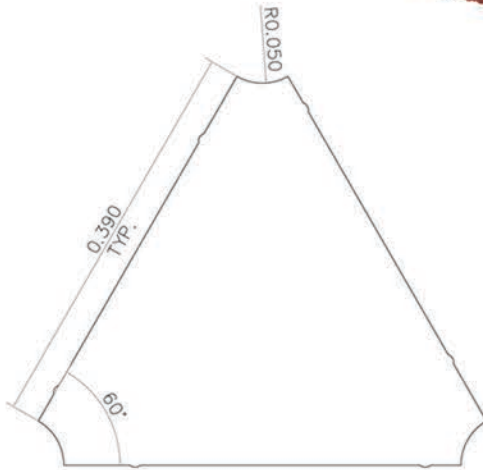

Length(mm)	200mm
Width(mm)	200mm
Thickness(mm)	60mm
No.Of Pieces Required For 1mArea	20.7pcs

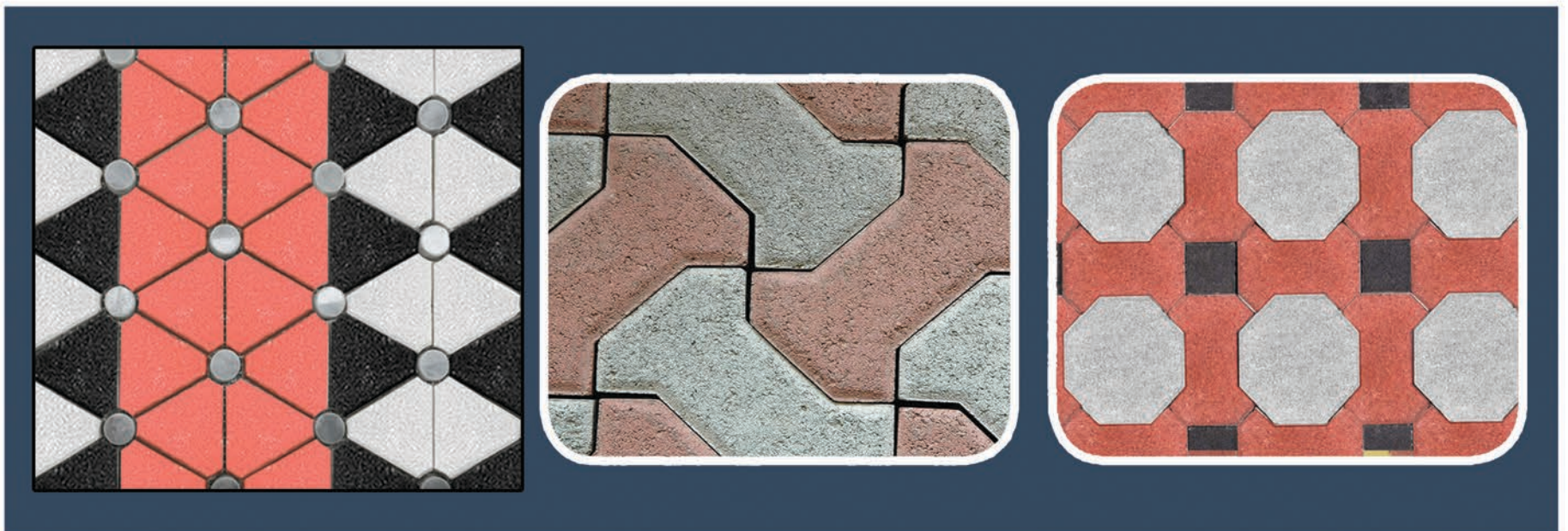
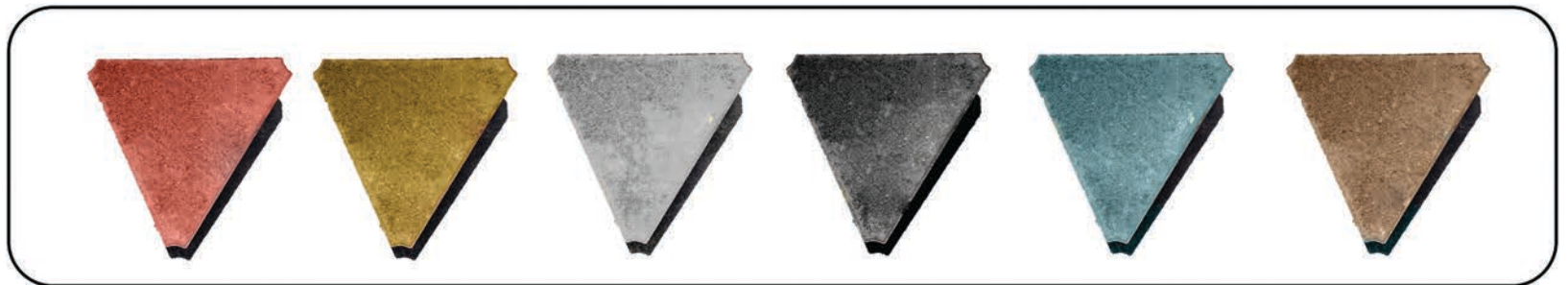



# PAVERS

## CYLINDER اسطوانة



Length(mm)	250mm
Width(mm)	200mm
Thickness(mm)	60mm
No.Of Pieces Required For 1mArea	20.4pcs

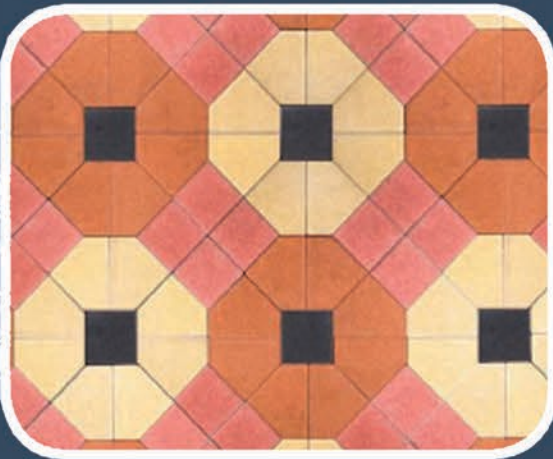





# سالم محي الدين SALEM MOHIYADDIN

SALEM MOHIYADDIN BIN SAIF & BROS. TRAD & CONT. CO. L.L.C  
PO BOX-145 , SALALAH-211 , TEL-(968) 23212102 FAX- (968) 23210171  
[www.salemgroups.com](http://www.salemgroups.com) [info@salemgroups.com](mailto:info@salemgroups.com)  
SULTANATE OF OMAN